

Liberty Garden Products

250' Model 885 Two Wheel Hose Cart Owner's Manual



VISIT OUR WEBSITE: WWW.LIBERTYGARDENPRODUCTS.COM OR
CALL US TOLL FREE AT 1-866-820-5805

LIBERTY GARDEN PRODUCTS, INC.
500 INDENEER DRIVE, SUITE 9, KERNERSVILLE NC 27284

IMPORTANT: READ THE OWNER'S MANUAL BEFORE ASSEMBLING

TOOLS REQUIRED: TWO ADJUSTABLE WRENCHES

Estimated assembly time: 30 minutes

PARTS LIST

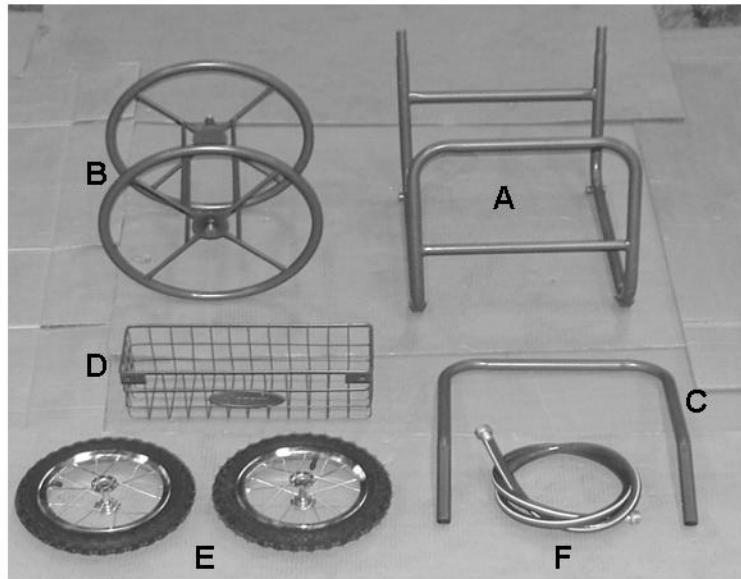

- A. FRAME (1 UNIT)
- B. SPOOL (1)
- C. U-HANDLE (1)
- D. BASKET (1)
- E. TIRES (2)
- F. LEADER HOSE (1)

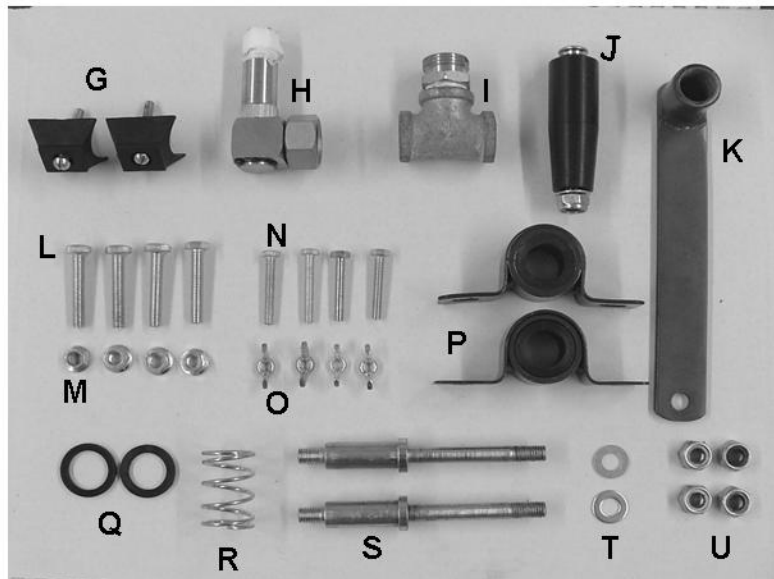

- G. RUBBER FEET W/NUTS (2)
- H. BRASS SWIVEL (1)
- I. GALVANIZED TEE (1)
- J. HANDLE WITH BOLT (1)
- K. CRANK HANDLE (1)
- L. U-BUSHING BOLTS (4)
- M. U-BUSHING NUTS (4)
- N. HANDLE BOLTS (4)
- O. HANDLE WING NUTS (4)
- P. U-BUSHING (2)
- Q. PLASTIC SPACER WASHER (2)
- R. SPRING (1)
- S. AXLE BOLT (2)
- T. AXLE WASHERS (2)
- U. AXLE NUTS (2)

IMPORTANT:

LAYOUT ALL PARTS AND FASTENERS. MAKE SURE ALL PARTS ARE ACCOUNTED FOR. IF ANY PART IS MISSING PLEASE CONTACT LIBERTY GARDEN PRODUCTS AT 1-866-820-5805. DO NOT CONTACT THE RETAILER. YOU CAN ALSO VISIT OUR WEBSITE, WWW.LIBERTYGARDENPRODUCTS.COM, FOR MORE INSTRUCTIONS, PICTURES AND HELPFUL HINTS.

1. Attach rubber feet (G) to bottom of the frame (A). Insert bolts into the bottom of the frame. Attach nuts and tighten. Repeat for other side. See Figure 1.

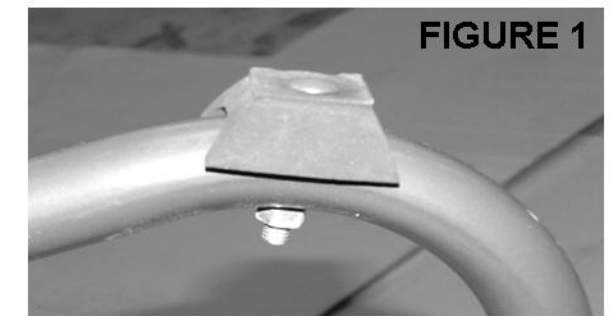

FIGURE 1

2. Turn frame over and attach one U-bushing (P) to frame (A) using two U-bushing bolts (L) and nuts (M). Hand tighten only. See Figure 2. Set Frame aside.

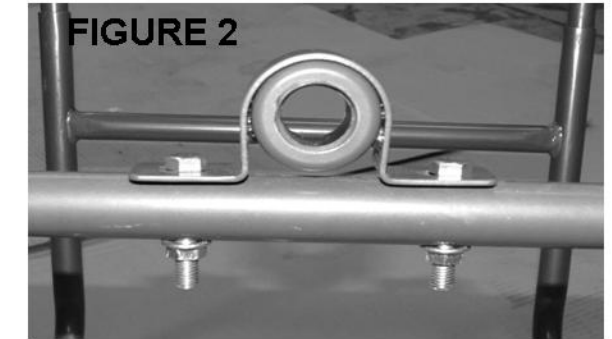

FIGURE 2

3. Insert the brass swivel (H) through the remaining U-bushing (P) and screw the end of the swivel into the galvanized tee (I). See Figure 3. Using a wrench, tighten the swivel into the galvanized tee. Tighten securely but do not over tighten. Over tightening the swivel could cause leakage.

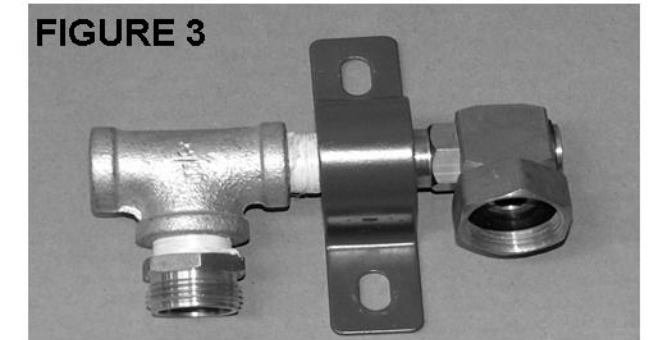

FIGURE 3

4. Screw the galvanized tee onto the spool end (B). Tighten with wrench. See Figure 4.

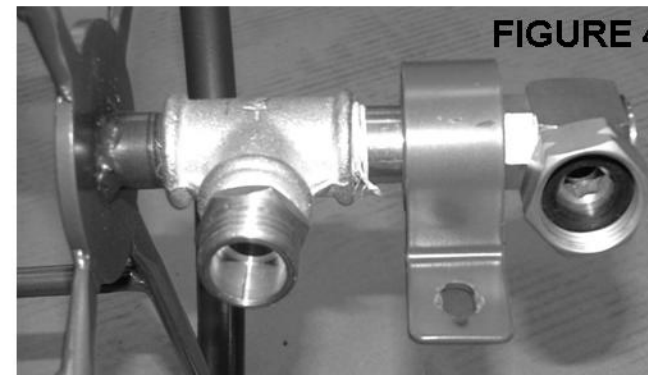

FIGURE 4

5. Turn the spool around and slide a plastic spacer washer (Q), spring (R) and another plastic spacer washer (Q) over the pipe. See Figure 5.

6. Attaching spool to frame: Insert "pipe" end of the spool into the U-bushing that you already attached to the frame in Step 2. See Figure 6.

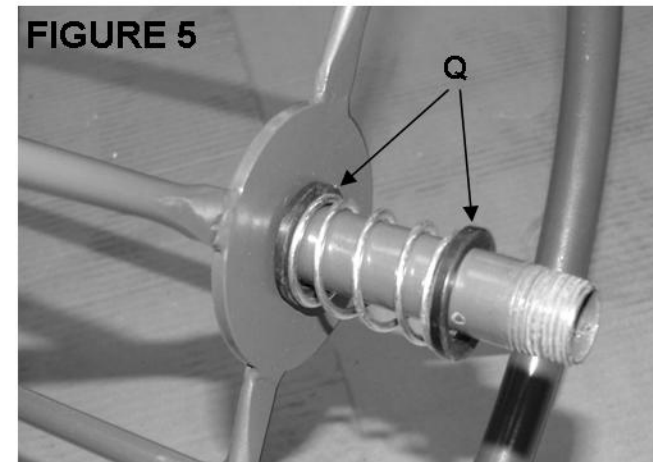

FIGURE 5

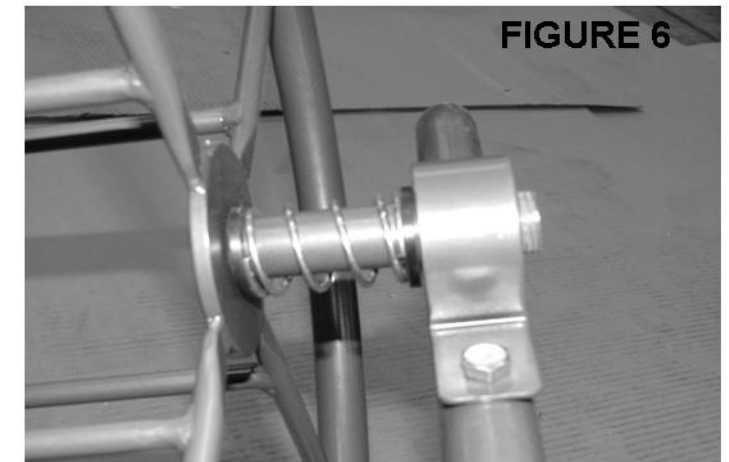

FIGURE 6

7. On the other end of the spool, align the U-bushing with the holes in the frame and insert U-bushing bolts (L) and attach nuts (M). You may need to compress the spring (R) to align holes. Tighten all four U-bushing nuts with a wrench.
See Figure 7.



8. Attach handle (J) to crank handle (K) using handle bolt and nut. Tighten securely. Attach crank handle to pipe on the end of the spool. Teflon tape should be on the end of the pipe to prevent leaking.
See Figure 8.

9. **Attaching wheels to the frame:** Insert axle Bolt (S) through the axle bushing on the frame (A). Put axle nut (U) on the axle. Hold the axle bolt with one wrench and tighten the nut on the inside of the frame with another wrench. Tighten securely. Repeat on remaining axle.
See Figure 9.

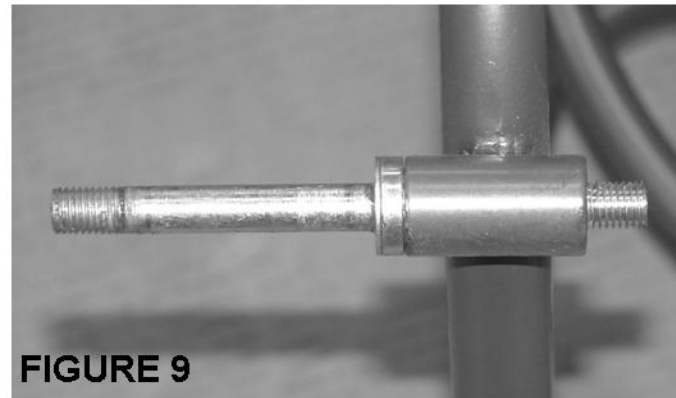

10. Place one tire (E) of the axle. Place axle washer (T) over the thread and screw on axle nut (U). Tighten securely. Repeat for the remaining tire.
See Figure 10,11.

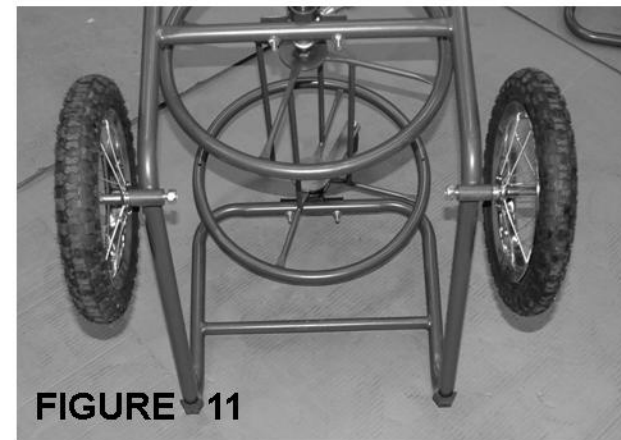

11. Attach basket (D) using handle bolts (N) and fasten with wing nuts (O) to the U-handle (C). Slide the U-handle (C) over the frame extensions and align the holes. Insert handle bolts (N) through the holes in the U-handle and fasten with wing nuts (M). Hand tighten.
See Figure 12.

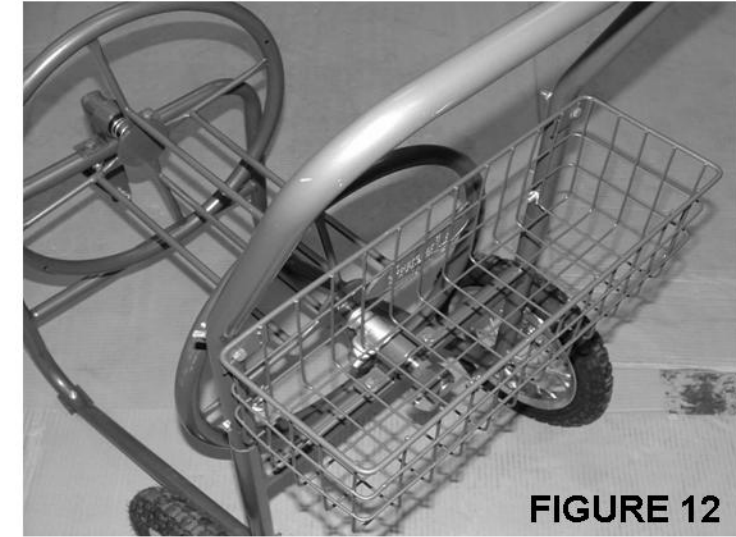

12. Attach the Leader Hose (F) to the end of the brass swivel (H). DO NOT OVERTIGHTEN>
See Figure 13.

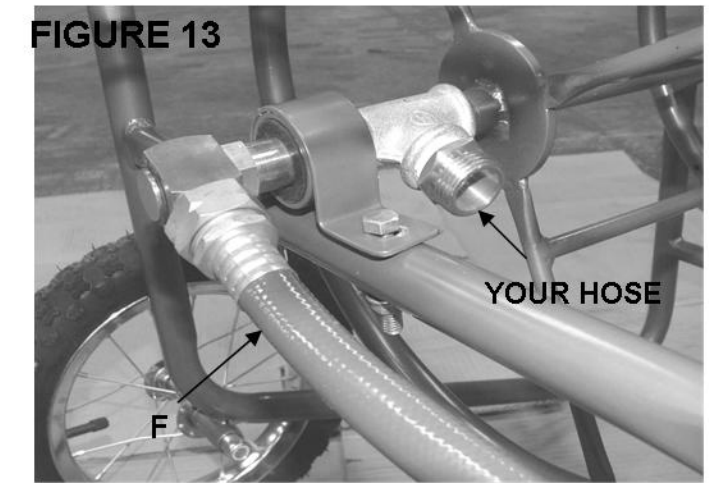

13. **Attaching Your Garden Hose:** Attach your hose to The brass adapter on the galvanized tee. Loop over the spool end to avoid kinking.
See Figure 14.

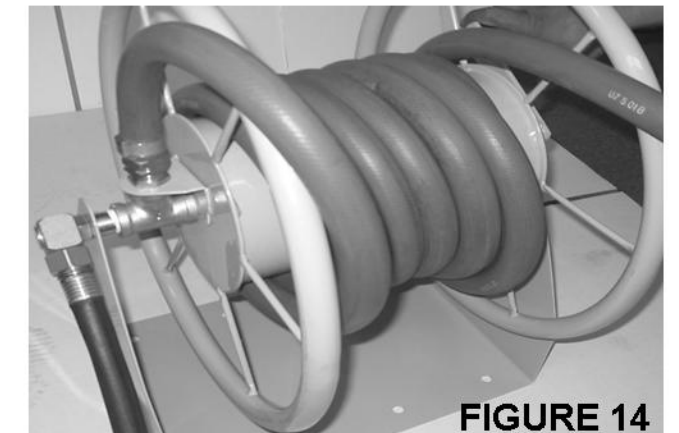

14. Your **Model 885** hose cart is now ready to use. Attach the end of the leader hose to your water supply.

MODEL 885 NOT SHOW IN FIGURE 14

Curing a Leaking Swivel

Problem:

Your new Liberty® hose reel or hose reel cart is leaking at the swivel.

Solution:

It is normal for the swivel to leak slightly until the O-rings are wet and have seated. If the leaking continues, you don't need to take the cart back to the store. This is a simple problem and is easily fixed by a simple procedure.

1. If the leader hose is attached to the swivel, unscrew the hose and look inside the swivel.
2. Using either a hex key or a large screw driver, insert the tool into the hex opening and gently tighten the threaded insert. **DO NOT OVER TIGHTEN!**
3. This should stop the leaking.
4. If the unit still leaks, please check that the hose washer is inside the nut. You may contact Liberty for a new hose washer or obtain one at any hardware store.
5. If your swivel is old, the O-Rings may be worn. Please contact us for a new set of O-Rings.
6. If these steps do not solve your leaking problem, then contact Liberty Garden.

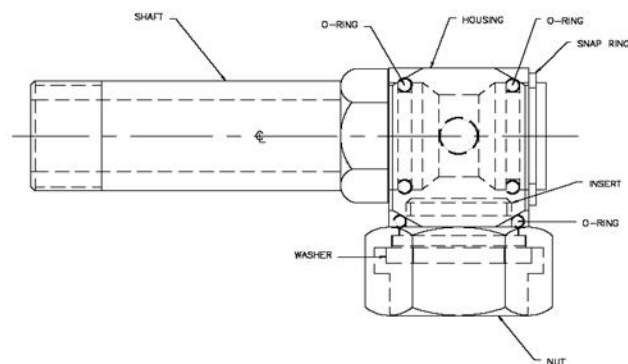

CALL US AT 1-866-820-5805 IF YOU HAVE ANY QUESTIONS REGARDING TROUBLESHOOTING AND WARRANTY

Care Instructions

Rust

Your Liberty™ hose reel will give you many seasons of reliable and functional hose storage. As with any steel product, there is always the chance for rust developing over time. Your Liberty™ hose reel finish is designed for industrial applications, but even the toughest of coatings can be compromised by scratches. Such minor surface damage can occur in shipping despite our best efforts. We have found that most scratches occur during assembly and/or installation (in the case of wall mounted hose reels). If the base metal is exposed to the elements long enough, rust will develop.

In the case of wall-mounted reels, be sure to use stainless steel mounting hardware. Also, remember to use the correct size and quantity of hardware to properly support the total weight of the unit. A standard 100' length of garden hose weighs approximately 15 pounds. Filled with water, the additional weight can exceed 20 pounds. The mounting hardware must be able to support the combined weight of the unit itself, hose, plus water.

We recommend that you periodically inspect your reel for any surface damage. Scratches can easily be repaired by using standard automotive touch-up body paint. Some of our most loyal customers recommend that at the end of each season, the unit be cleaned and painted with a clear acrylic paint.

Two other sources of rust acceleration is exposing the reel to yard fertilizers or leaving your hose reel standing in grass. Be sure to rinse off your hose reel after it comes in contact with freshly fertilized grass. Also, try to park your hose reel on solid ground. Leaving it standing on top of vegetation promotes condensation on the undercarriage of the unit.

Leaks

Your Liberty™ hose reel is manufactured with the finest quality components available. All components are manufactured to rigorous quality standards not common in other consumer grade hose reels available today. When you install your Liberty™ hose reel, be sure the hose washers are in place and all fittings are secure. **DO NOT OVER TIGHTEN** as you might damage the components. If you live in more temperate climates, be sure to drain the unit of any residual water before storing. **DO NOT EXPOSE THE UNIT TO FREEZING TEMPERATURES** while water remains in the plumbing system.

Troubleshooting Guide

Problem: Swivel head is not rotating, causing the leader hose to kink up.

Solution: Remove leader hose and turn the square head of the swivel several times; apply lubricant.

Problem: Leaking Fixtures (galvanized tee; brass coupling; swivel)

Solution: Apply Teflon/Plumber's Tape or/and make sure fixtures are tightened.

TIPS

- **DO NOT** use a compressor while inflating the tires; hand pump only. 15 PSI maximum
- To help delay rust, check for any scratches on your hose cart. Apply clear acrylic/weatherproof paint to avoid rusting.
- Drain water before storing.
- **DO NOT** drink water from the hose.

Warranty & Care

Our guarantee is as functional and straight-forward as our products. Since we design and build our products to provide you with many years of satisfaction, all Liberty™ products are guaranteed against defects in materials and workmanship.

In the unlikely event that a problem arises as a result of a defect in our materials or workmanship, we will promptly repair or replace the item at our expense. All we require is that you contact us first and we'll take it from there.

It is important to note that our guarantee is not an unconditional guarantee for the life of the product. Liberty™ hose stands and reels are made from the finest materials available under our exacting manufacturing standards. But, like any other product, it is not indestructible. Therefore, our guarantee does not cover:

- Product damage that is a result of abuse, misuse, or mishandling. (Exposing the unit to freezing temperatures with water remaining in the reel plumbing system voids the unit warranty.)
- **Rust.** Despite the industrial quality coating and our best efforts, steel will rust over time.
- Incidental damage or consequential damages or injury to persons or to other property not purchased from us due to the use of our product.
- Do **NOT** consume water from garden hose. It is not fit for human consumption.
If there is damage to the product that occurred as a result of shipping, you should file a damage claim with the carrier.

As with any product, it should be expected that component parts - particularly moving parts, seals, o-rings, wheels, hose, and connectors will wear with use and over time may need to be replaced or refurbished. This type of normal wear and tear is naturally not covered by our guarantee, but we will always be happy to provide you with prompt, high quality service and replacement parts at a nominal cost.

This warranty gives you specific legal rights, and you may also have other rights which vary from state to state. (Some states do not allow the exclusion or limitation of incidental or consequential damages, so the above limitation may not apply to you).

You will find that we apply the same standard of excellence to our customer service as we do to our products.

Warning! This product contains one or more chemicals known to the State of California to cause cancer and birth defects or other reproductive harm. Wash hands after handling.

