

# Liberty Garden Model #712

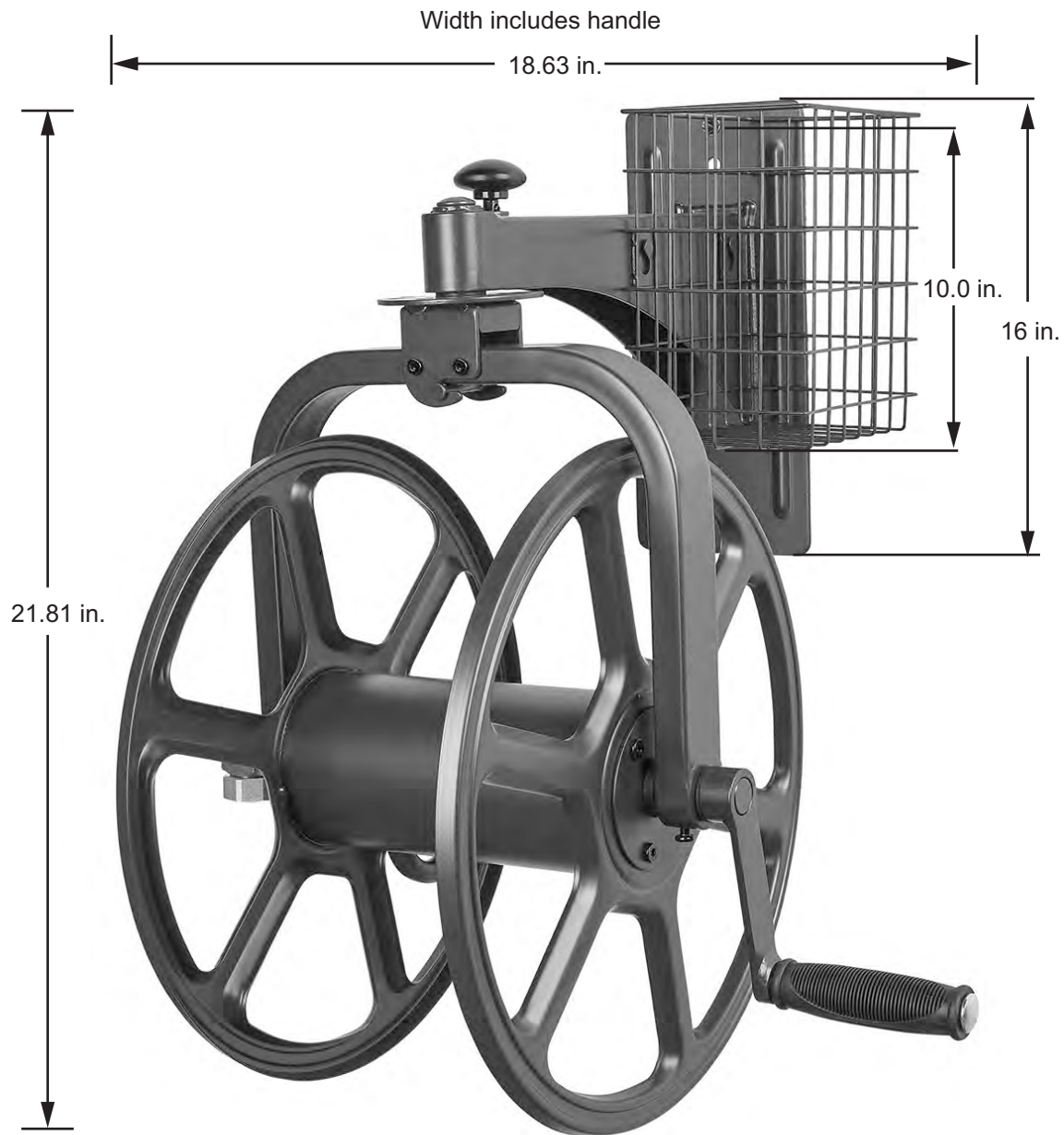

**This hose reel must be mounted to a solid masonry wall or to wall studs**

**TIP:** Remember to use the correct size and quantity of hardware to properly support the total weight of the unit. A standard 100' length of garden hose weighs approximately 15 lbs. Filled with water, the additional weight can exceed 20 lbs. The mounting hardware must be able to support the combined weight of the unit, garden hose, plus water.